

Contractor: _____

Project: _____

RTSPUC5

Quantity: _____

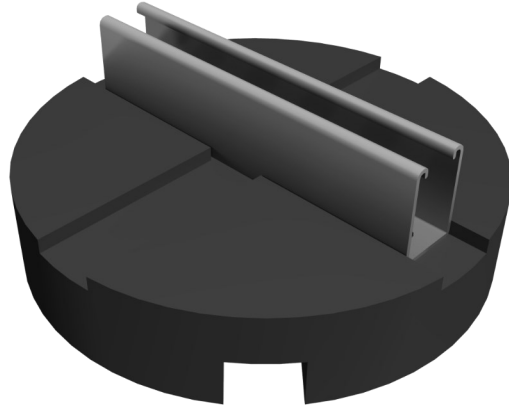

Non-penetrating pipe support for roof mounted gas, conduit, solar, or other mechanical piping.

Base Material: Compression molded recycled rubber (97% recycled material).

Base Dimensions: 12-inch Diameter. 71.5 in² surface contact.

Pipe Clearance: Fixed height of 5-1/4 inches.

Maximum Load Weight: Based on structural capacity of structure:

140 lbs. at 2 PSI, 210 lbs. at 3 PSI (per pipe support)

Pipe Rests on 10" x 1-5/8" x 3-1/4" 12-gauge strut channel.

Hardware finish: [Electrogalvanized] or [Stainless Steel].

Strut finish: [Electrogalvanized], [Hot Dip Galvanized], or [Stainless Steel].

Spacing: Horizontal support spacing according to pipe specification, or horizontal pipe support spacing according to applicable building code. Do not exceed manufacturer's suggested spacing of 8-foot centers as loading permits.

Installation Instructions:

1. Place base on roof based on design layout.
2. Run pipe accordingly.
3. Connect pipe to base using pipe clamp or roller per application requirements.

****NOTE: No adhesive is to be used with this product to attach to the roof.

